

## IEG1-38529-10-V

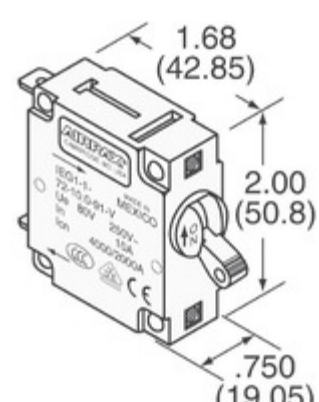

Obrázky jsou pouze orientační.  
Podrobné informace o produktu naleznete v části Technické údaje produktu.  
**Koupit IEG1-38529-10-V s důvěrou od Component-World.HK, 1 rok záruka**



**Part Number:** [IEG1-38529-10-V](#)  
**Výrobce:** [Sensata Technologies, Airpax](#)  
**Popis:** CIR BRKR MAG-HYDR LEVER  
**Datový list:** [IEG,IUG,IEG,CEG,LEG Series Datasheet](#)

**RoHS Status:** Bez olova / V souladu RoHS  
**Ship From:** Hong Kong  
**Shipment Way:** DHL/Fedex/TNT/UPS/EMS

[Request For Quotation](#)













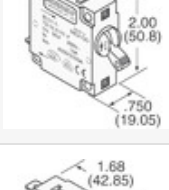
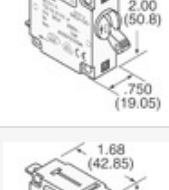

### PARAMETR PRODUKTU

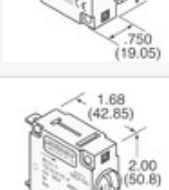
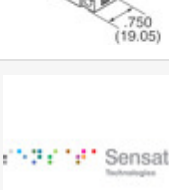
<b>Part Number</b>	IEG1-38529-10-V	<b>Výrobce</b>	<a href="#">Sensata Technologies, Airpax</a>
<b>Popis</b>	CIR BRKR MAG-HYDR LEVER	<b>Stav volného vedení / RoHS</b>	Bez olova / V souladu RoHS
<b>Dostupné množství</b>	2874 pcs	<b>Datový list</b>	<a href="#">IAG,IUG,IEG,CEG,LEG Series Datasheet</a>
<b>Kategorie</b>	<a href="#">Ochrana obvodu</a>	<b>Série</b>	IEG
<b>Počet pólů</b>	1	<b>Typ montáže</b>	Panel Mount
<b>Úroveň citlivosti na vlhkost (MSL)</b>	1 (Unlimited)	<b>Výrobní standardní doba výroby</b>	6 Weeks
<b>Stav volného vedení / RoHS</b>	Lead free / RoHS Compliant	<b>Osvětlení napětí (nominální)</b>	-
<b>Osvětlení</b>	-	<b>Jmenovitá hodnota proudu</b>	-
<b>Breaker Typ</b>	Magnetic (Hydraulic Delay)	<b>Pohon Type</b>	Lever

Component-World.com je spolehlivý distributor elektronických součástek. Specializujeme se na všechny elektronické komponenty řady Sensata Technologies, Airpax. Máme 2874 kusy Sensata Technologies, Airpax IEG1-38529-10-V na skladě dostupných. Vyžádejte si citát z distributora součástí elektroniky na Component-World.com, náš prodejní tým vás bude kontaktovat do 24 hodin.

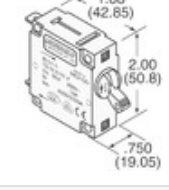
RFQ Email: [info@Components-World.com](mailto:info@Components-World.com)

### SOUVISEJÍCÍ PRODUKTY

	<b>Část#:</b> <a href="#">IEG1-36595-10-V</a> <b>Popis:</b> CIR BRKR MAG-HYDR LEVER	<b>Výrobci:</b> <a href="#">Sensata Technologies, Airpax</a>	<a href="#">Dotaz</a>
	<b>Část#:</b> <a href="#">IEG11-0-SW-30.0-91-V</a> <b>Popis:</b> CIR BRKR MAG-HYDR LEVER 30A	<b>Výrobci:</b> <a href="#">Sensata Technologies, Airpax</a>	<a href="#">Dotaz</a>
	<b>Část#:</b> <a href="#">IEG11-1-52-15.0-01-V</a> <b>Popis:</b> CIR BRKR MAG-HYDR	<b>Výrobci:</b> <a href="#">Sensata Technologies, Airpax</a>	<a href="#">Dotaz</a>
	<b>Část#:</b> <a href="#">IEG1-36628-2-V</a> <b>Popis:</b> CIR BRKR MAG-HYDR LEVER	<b>Výrobci:</b> <a href="#">Sensata Technologies, Airpax</a>	<a href="#">Dotaz</a>
	<b>Část#:</b> <a href="#">IEG11-1-52-30.0-A-01-V</a> <b>Popis:</b> CIR BRKR MAG-HYDR	<b>Výrobci:</b> <a href="#">Sensata Technologies, Airpax</a>	<a href="#">Dotaz</a>
	<b>Část#:</b> <a href="#">IEG1-36628-1-V</a> <b>Popis:</b> CIR BRKR MAG-HYDR LEVER	<b>Výrobci:</b> <a href="#">Sensata Technologies, Airpax</a>	<a href="#">Dotaz</a>
	<b>Část#:</b> <a href="#">IEG1-37009-10-V</a> <b>Popis:</b> CIR BRKR MAG-HYDR LEVER	<b>Výrobci:</b> <a href="#">Sensata Technologies, Airpax</a>	<a href="#">Dotaz</a>
	<b>Část#:</b> <a href="#">IEG1-37101-1-V</a> <b>Popis:</b> CIR BRKR MAG-HYDR LEVER	<b>Výrobci:</b> <a href="#">Sensata Technologies, Airpax</a>	<a href="#">Dotaz</a>
	<b>Část#:</b> <a href="#">IEG11-1-52-20.0-01-V</a> <b>Popis:</b> CIR BRKR MAG-HYDR LEVER 20A	<b>Výrobci:</b> <a href="#">Sensata Technologies, Airpax</a>	<a href="#">Dotaz</a>
	<b>Část#:</b> <a href="#">IEG1-38529-3-V</a> <b>Popis:</b> CIR BRKR MAG-HYDR LEVER	<b>Výrobci:</b> <a href="#">Sensata Technologies, Airpax</a>	<a href="#">Dotaz</a>
	<b>Část#:</b> <a href="#">IEG1-37009-16-V</a> <b>Popis:</b> CIR BRKR MAG-HYDR LEVER	<b>Výrobci:</b> <a href="#">Sensata Technologies, Airpax</a>	<a href="#">Dotaz</a>
	<b>Část#:</b> <a href="#">IEG11-1-51-30.0-01-V</a> <b>Popis:</b> CIR BRKR MAG-HYDR LEVER 30A	<b>Výrobci:</b> <a href="#">Sensata Technologies, Airpax</a>	<a href="#">Dotaz</a>
	<b>Část#:</b> <a href="#">IEG1-36569-30-V</a> <b>Popis:</b> CIR BRKR MAG-HYDR LEVER	<b>Výrobci:</b> <a href="#">Sensata Technologies, Airpax</a>	<a href="#">Dotaz</a>
	<b>Část#:</b> <a href="#">IEG1-36628-4-V</a> <b>Popis:</b> CIR BRKR MAG-HYDR LEVER	<b>Výrobci:</b> <a href="#">Sensata Technologies, Airpax</a>	<a href="#">Dotaz</a>
	<b>Část#:</b> <a href="#">IEG11-1-42-20.0-01</a> <b>Popis:</b> CIR BRKR MAG-HYDR	<b>Výrobci:</b> <a href="#">Sensata Technologies, Airpax</a>	<a href="#">Dotaz</a>
	<b>Část#:</b> <a href="#">IEG1-38854-1-V</a> <b>Popis:</b> CIR BRKR MAG-HYDR LEVER	<b>Výrobci:</b> <a href="#">Sensata Technologies, Airpax</a>	<a href="#">Dotaz</a>
	<b>Část#:</b> <a href="#">IEG1-37130-10-V</a> <b>Popis:</b> CIR BRKR MAG-HYDR LEVER	<b>Výrobci:</b> <a href="#">Sensata Technologies, Airpax</a>	<a href="#">Dotaz</a>
	<b>Část#:</b> <a href="#">IEG1-39684-16-V</a> <b>Popis:</b> CIR BRKR MAG-HYDR LEVER	<b>Výrobci:</b> <a href="#">Sensata Technologies, Airpax</a>	<a href="#">Dotaz</a>
	<b>Část#:</b> <a href="#">IEG1-36628-3-V</a> <b>Popis:</b> CIR BRKR MAG-HYDR LEVER	<b>Výrobci:</b> <a href="#">Sensata Technologies, Airpax</a>	<a href="#">Dotaz</a>
	<b>Část#:</b> <a href="#">IEG11-1-52-10.0-A-01-V</a> <b>Popis:</b> CIR BRKR MAG-HYDR 10A LEVER	<b>Výrobci:</b> <a href="#">Sensata Technologies, Airpax</a>	<a href="#">Dotaz</a>

### Související klíčová slova pro IEG1-38529-10-V

Sensata Technologies, Airpax IEG1-38529-10-V.	IEG1-38529-10-V distributor	IEG1-38529-10-V dodavatel	IEG1-38529-10-V Cena
IEG1-38529-10-V Stáhnout datasheet.	IEG1-38529-10-V Datasheet.	IEG1-38529-10-V Stock.	koupit IEG1-38529-10-V.
Sensata Technologies, Airpax IEG1-38529-10-V.	Sensata Technologies/Airpax IEG1-38529-10-V.		